

# Sample- Site Plan

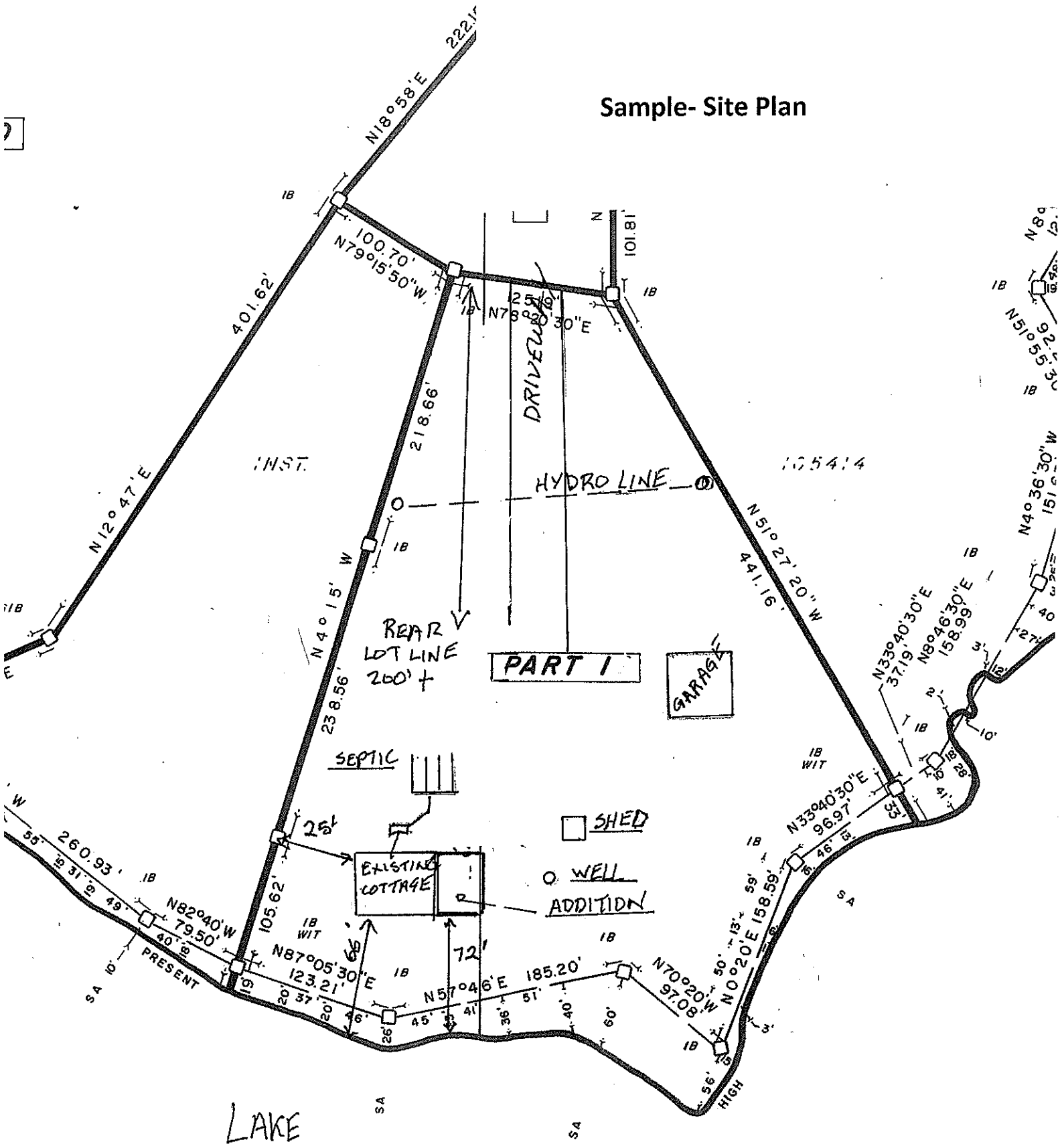

## Sample Plan- Dwelling

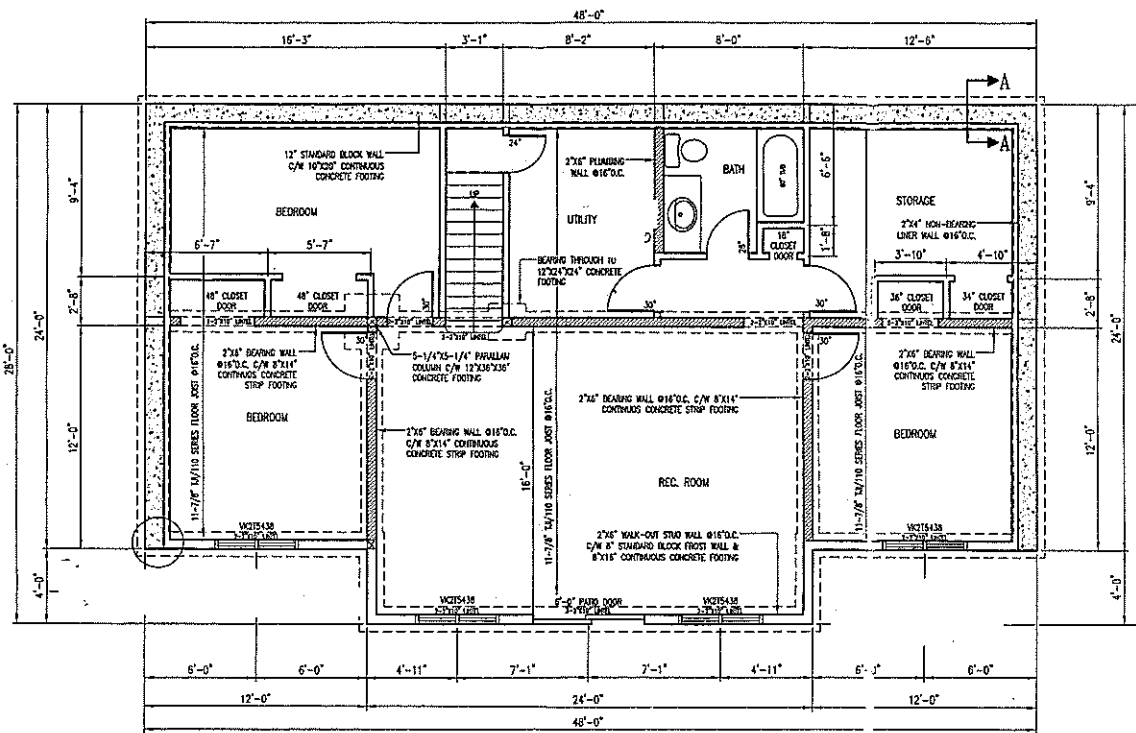

**FOUNDATION PLAN**

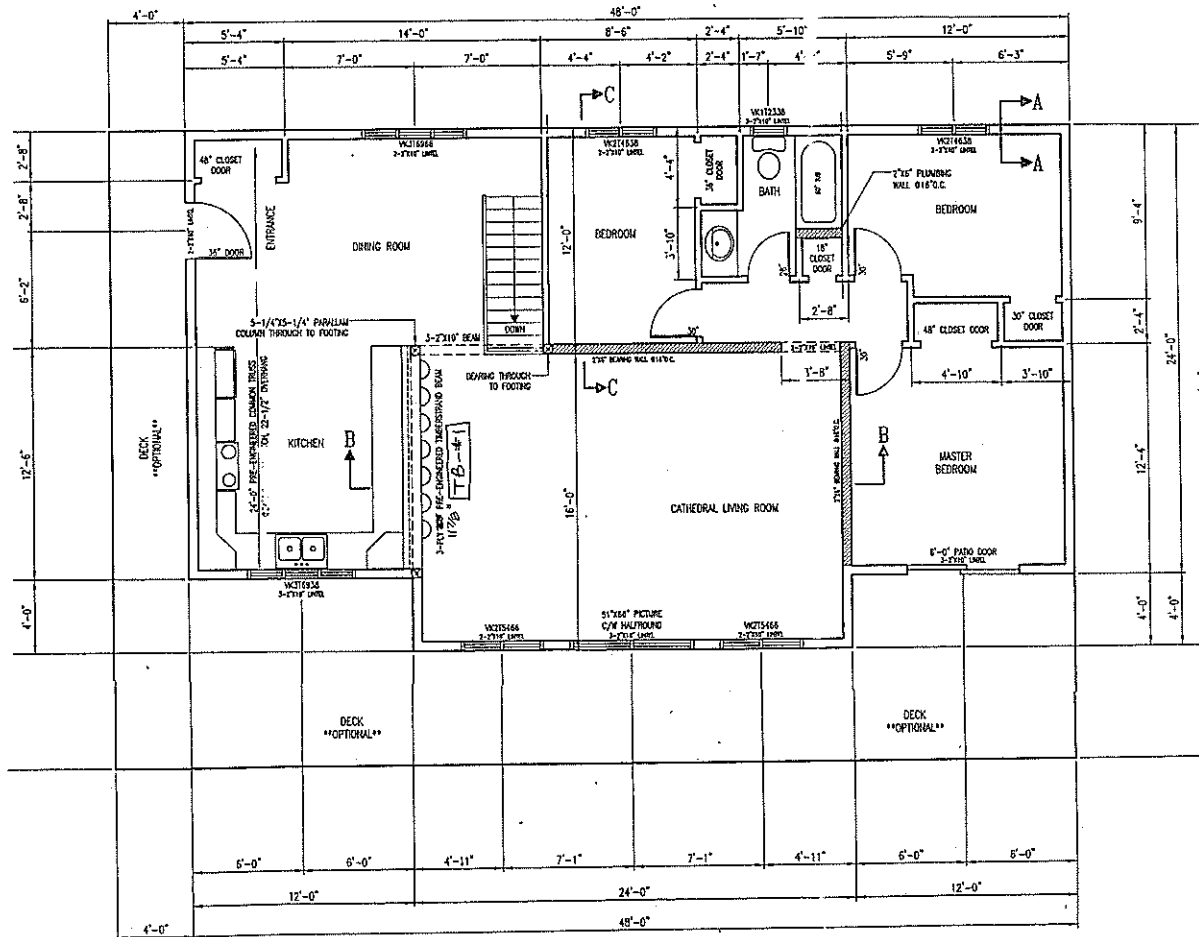

**FLOOR PLAN**

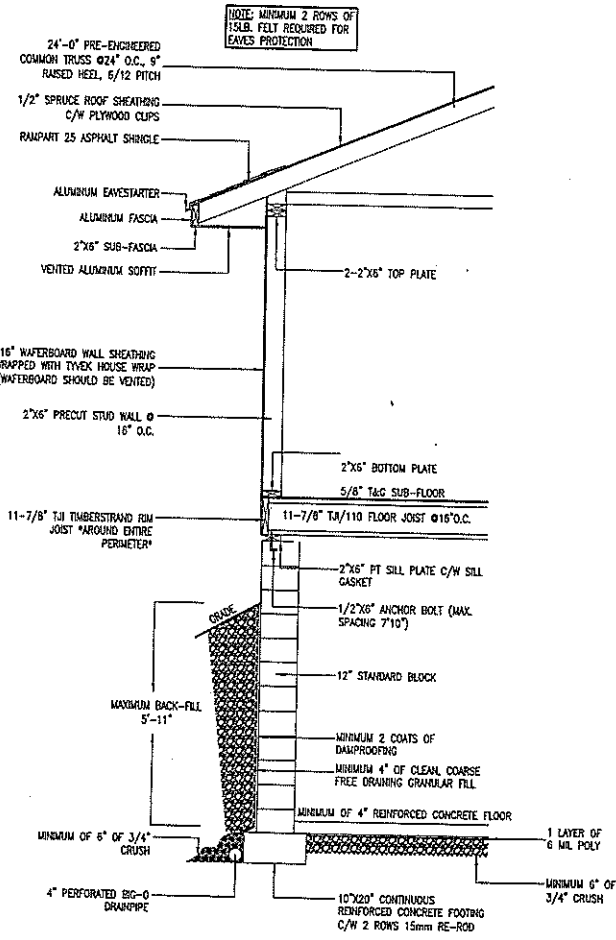

**DETAIL SECTION A-A**

SCALE 1/2"=1'-0"

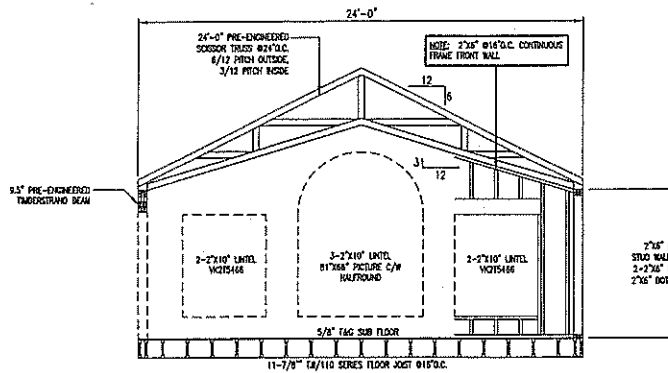

**CROSS SECTION B-B**

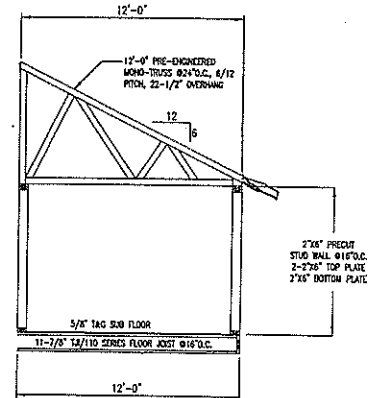

**TRUSS DETAIL C-C**

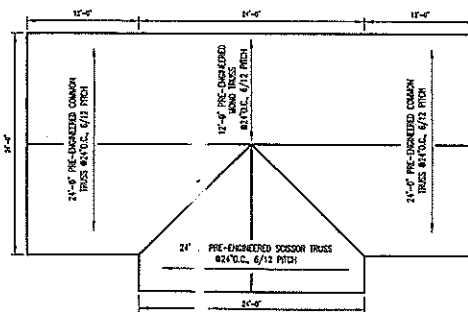

**ROOF PLAN**

SCALE 1/8"=1'-0"

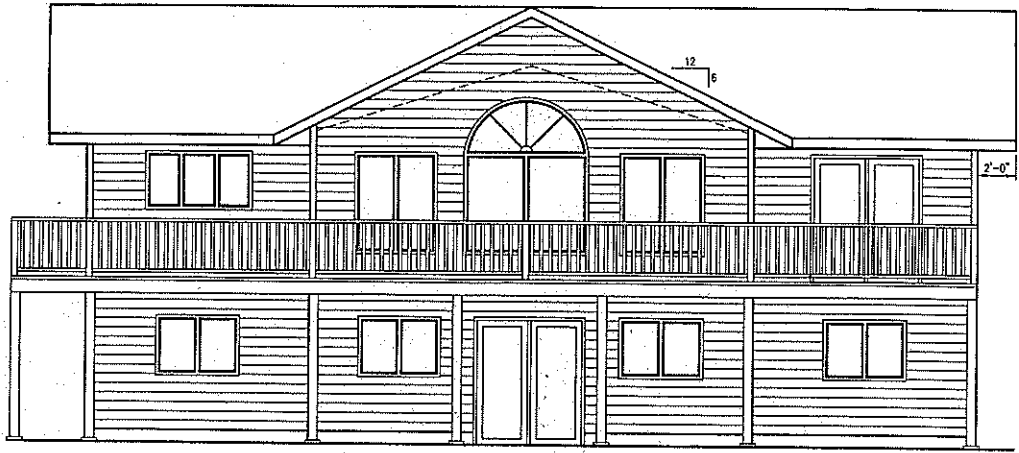

FRONT ELEVATION

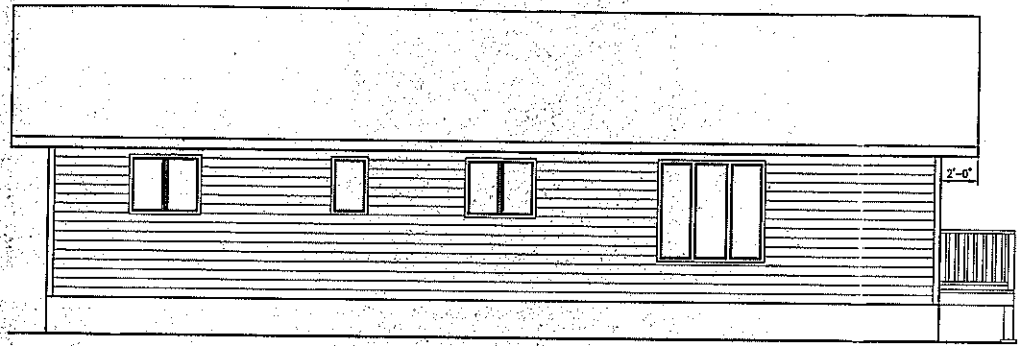

BACK ELEVATION

LEFT SIDE ELEVATION

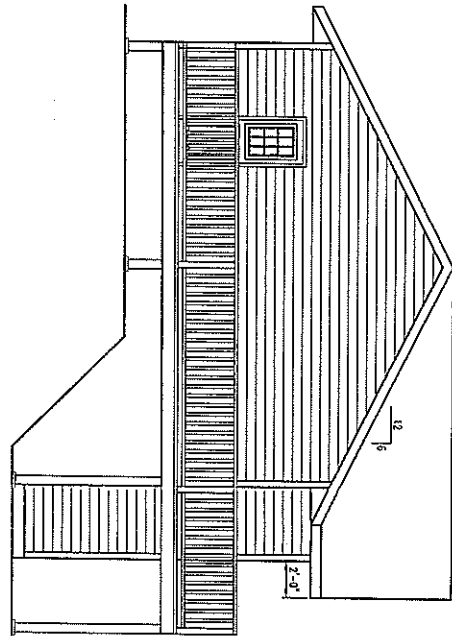

RIGHT SIDE ELEVATION

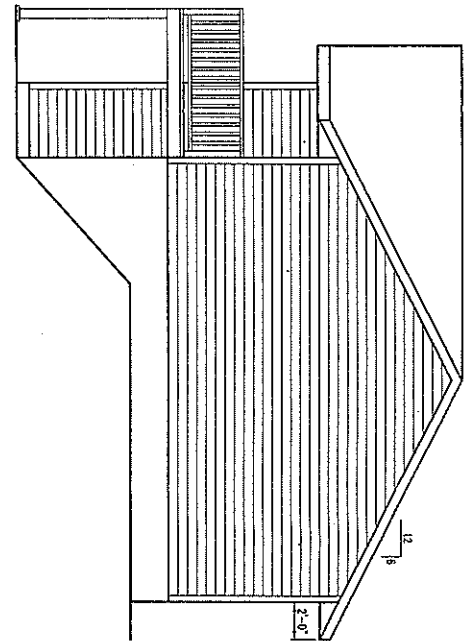

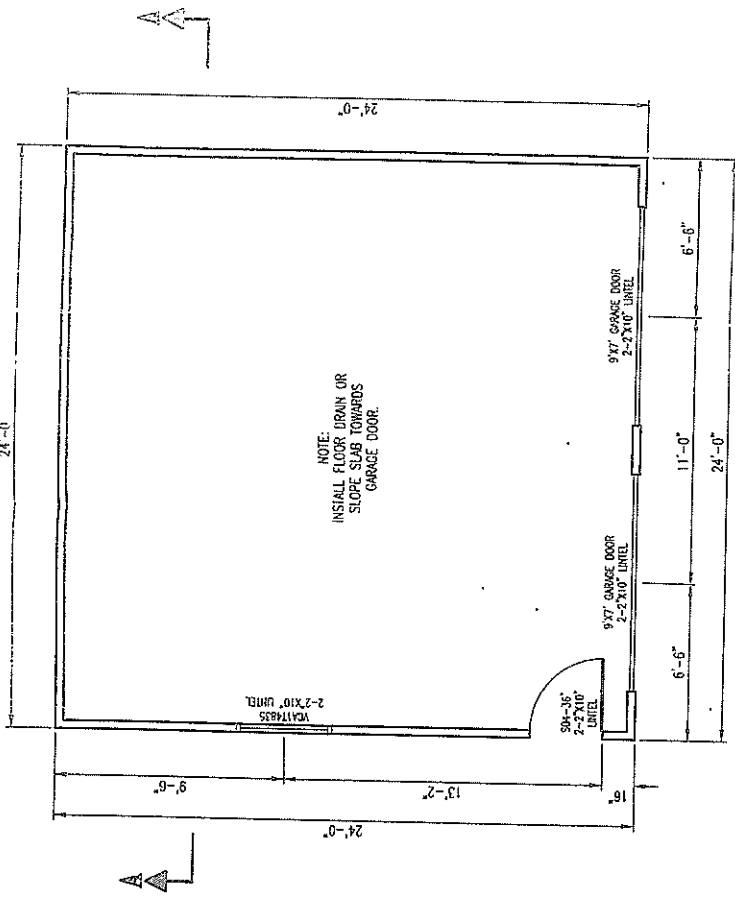

GARAGE PLAN

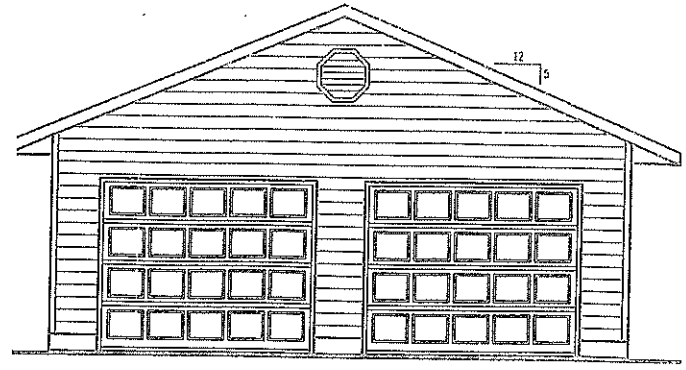

FRONT ELEVATION

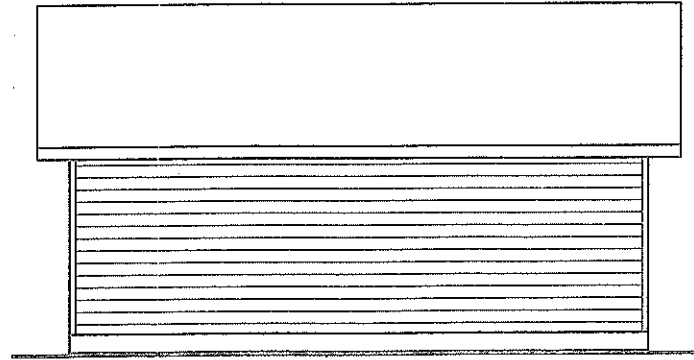

RIGHT SIDE ELEVATION

Sample Plan- Garage

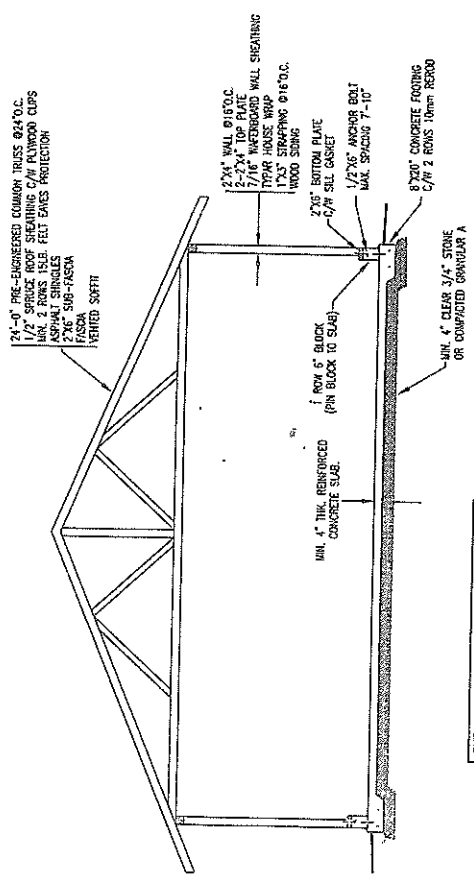

CROSS SECTION A-A

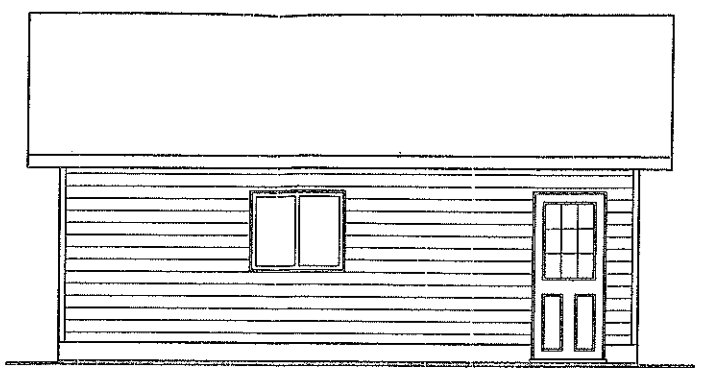

LEFT SIDE ELEVATION

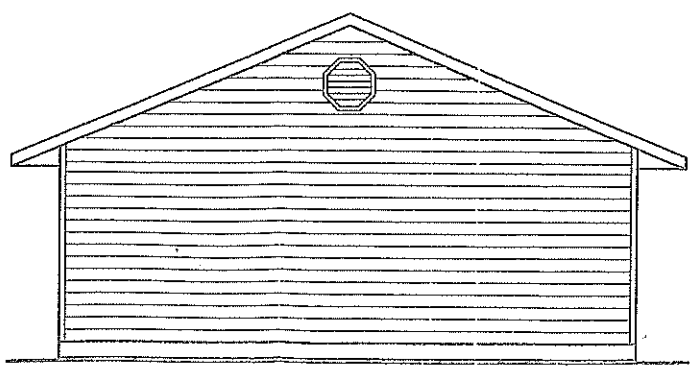

BACK ELEVATION

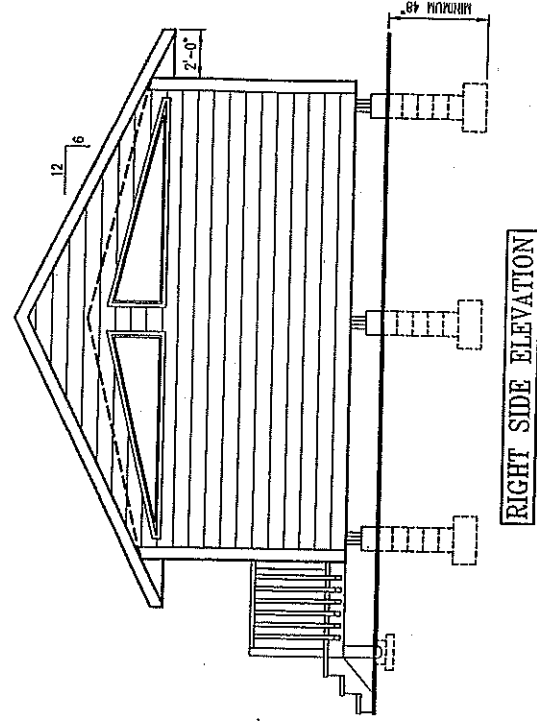
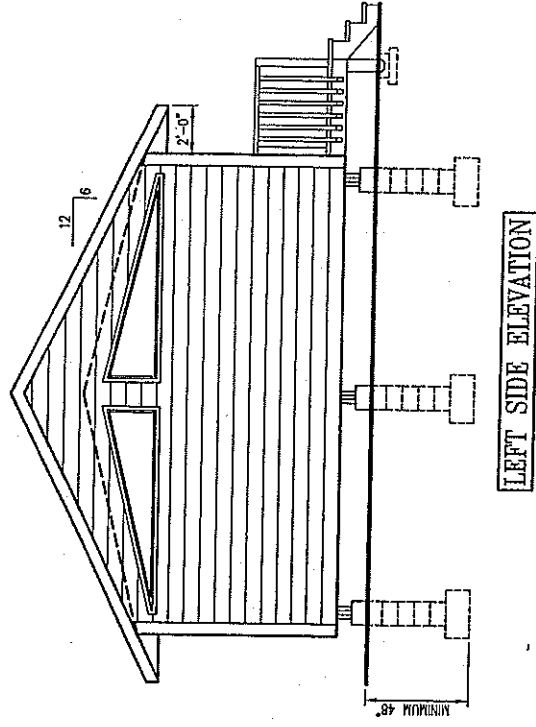
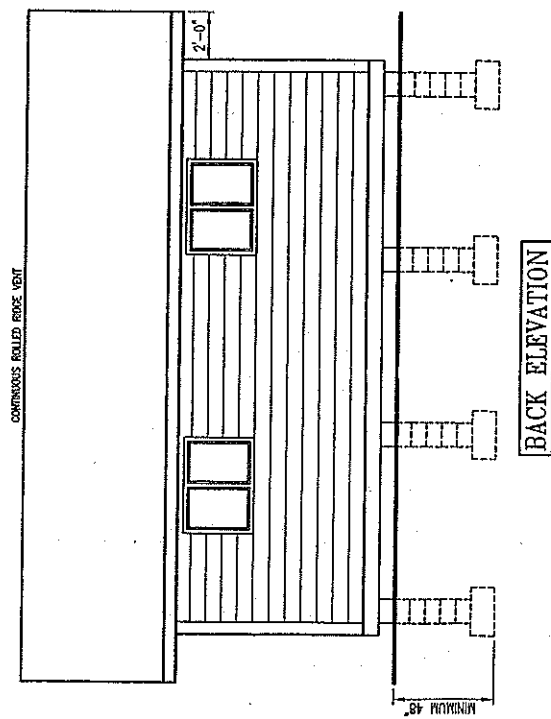
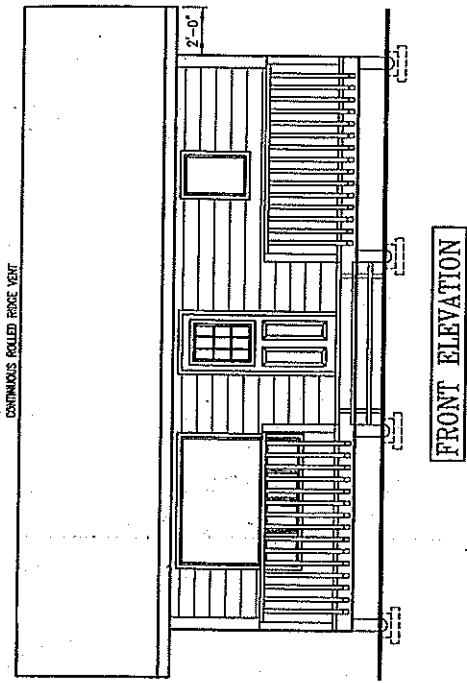

**Sample Plan – Private Cabin ( Bunkie )**

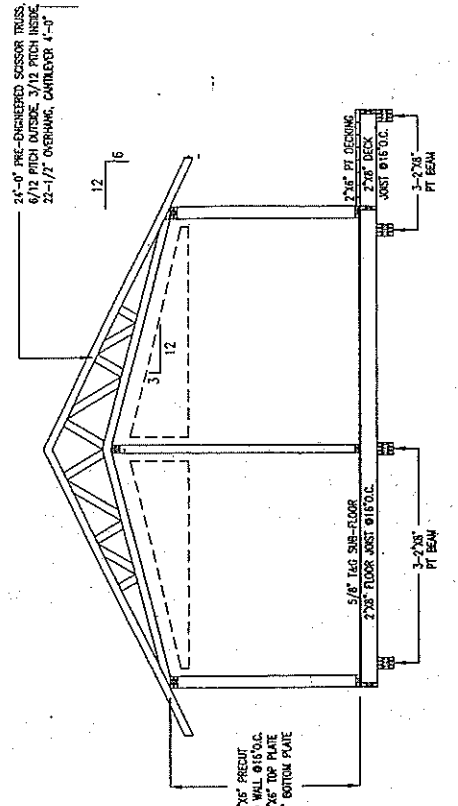
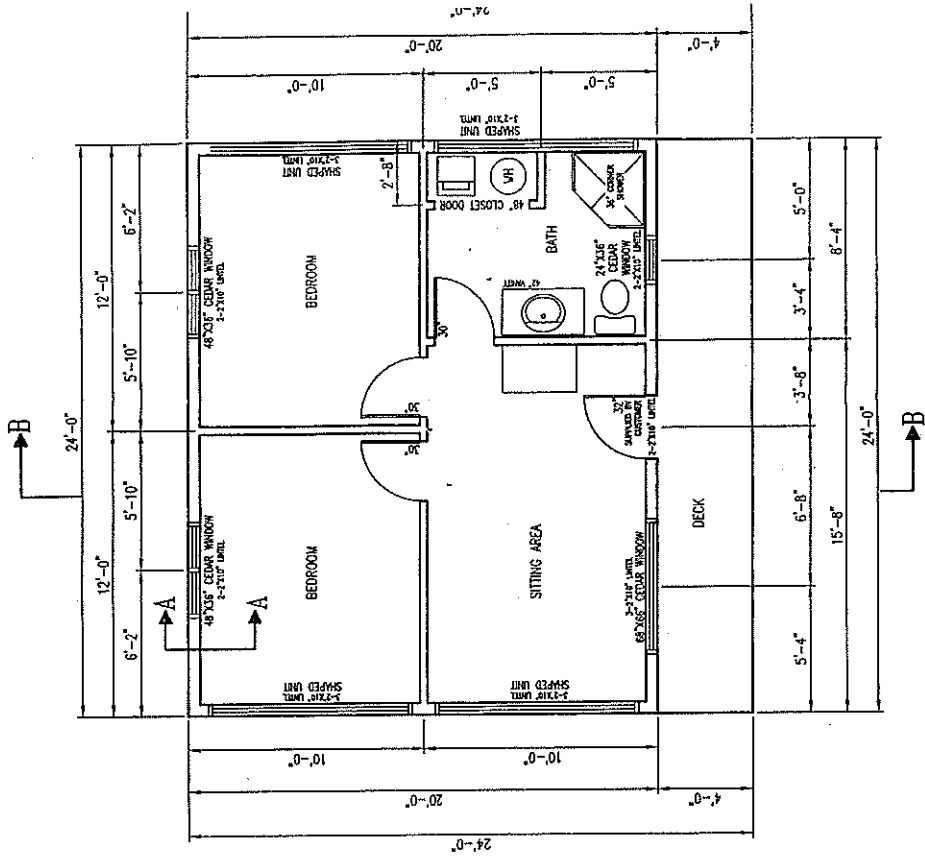

CROSS SECTION B-B

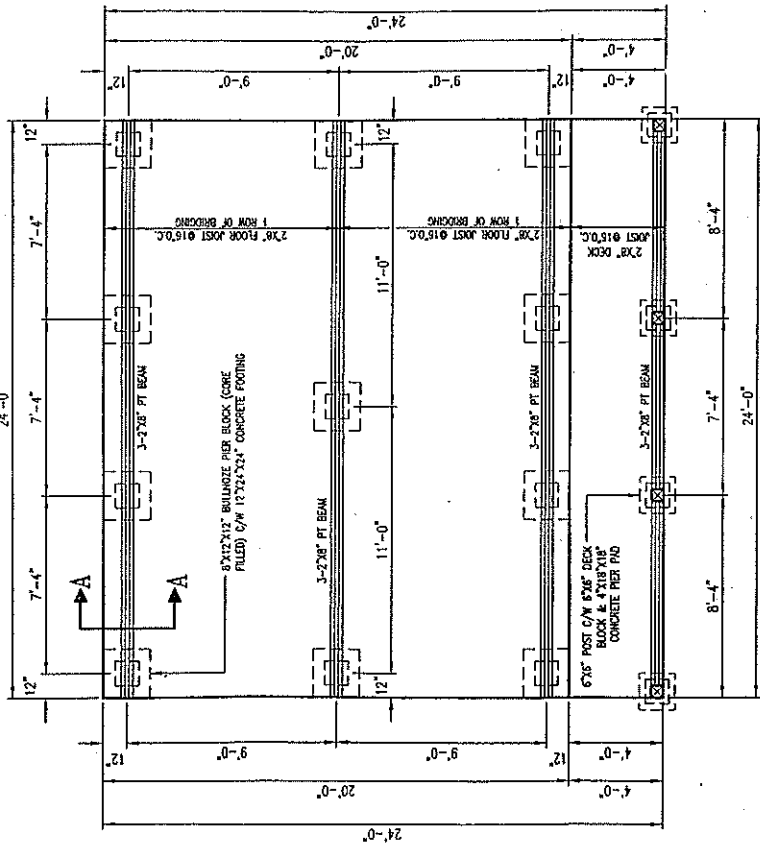

CROSS SECTION A-A

SCALE: 1/2"=1'-0"

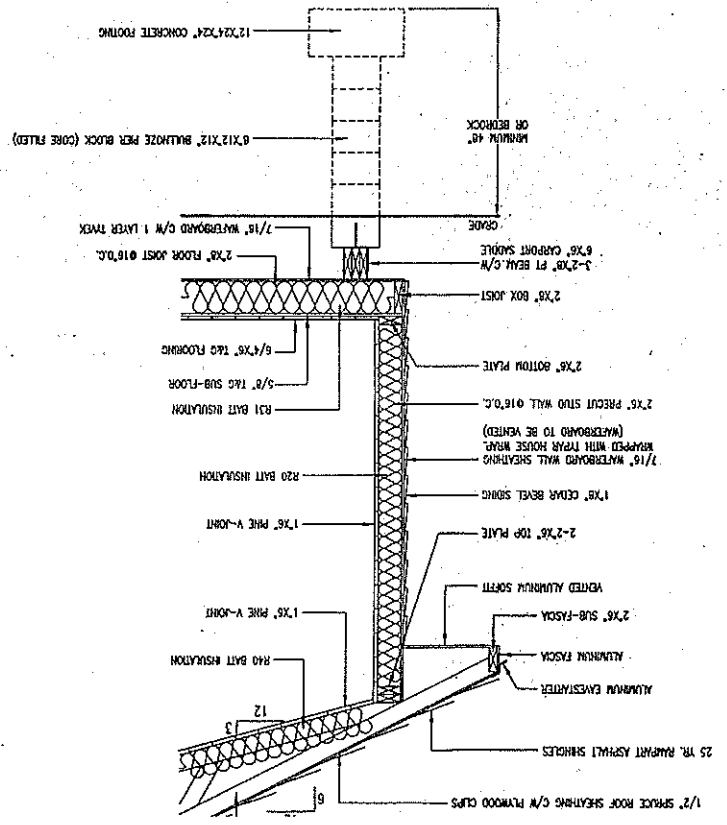

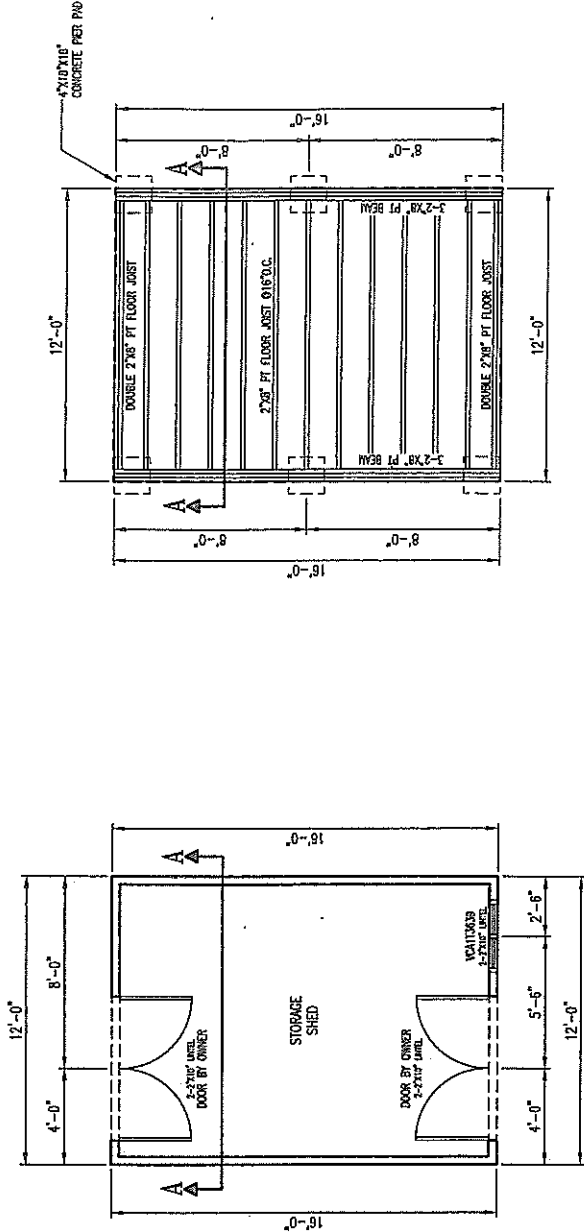

PIER PLAN

FLOOR PLAN

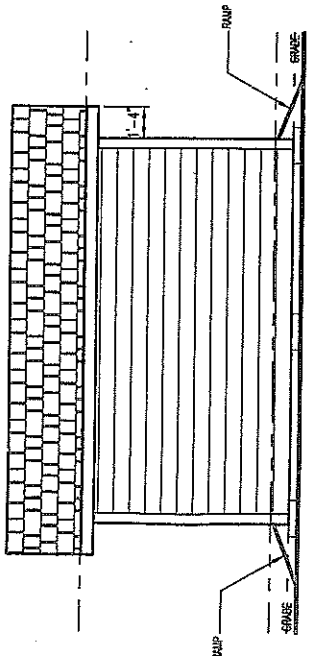

RIGHT SIDE ELEVATION

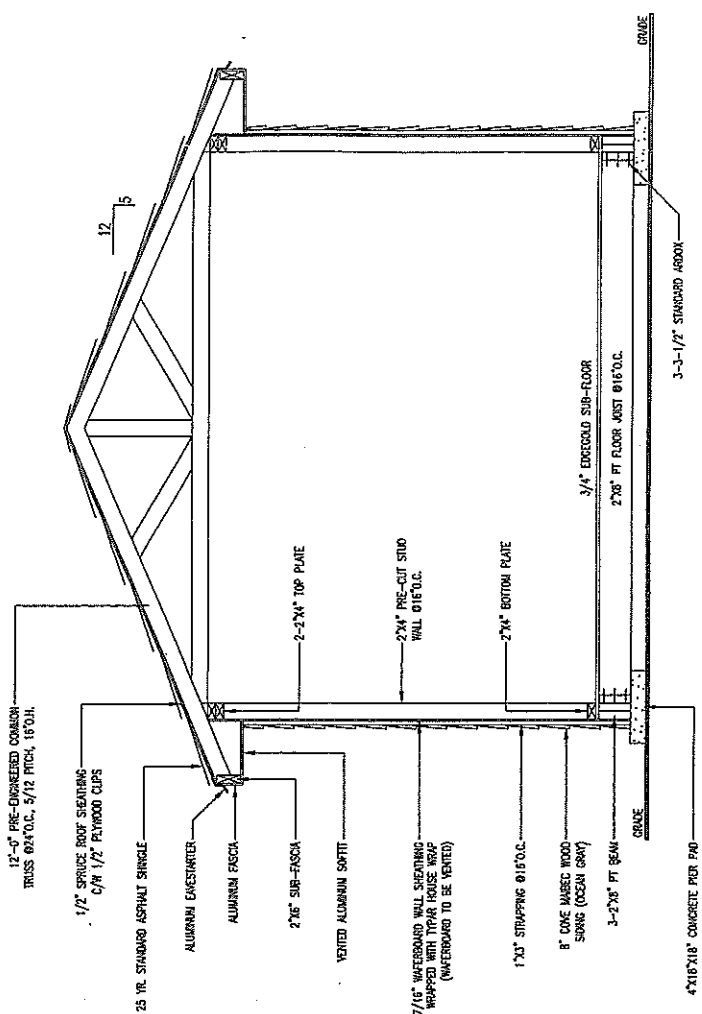

DETAIL SECTION A-A

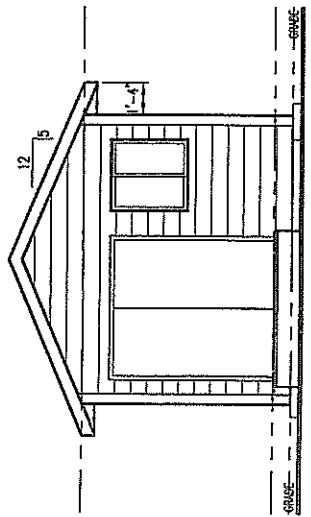

FRONT ELEVATION

Sample Plan - Shed

12'-0" PRE-ENGINEERED COMMON TRUSS @24"O.C., 5/12 PITCH, 18'0"H.

1/2" SPRUCE ROOF SHEATHING C/W 1/2" FLYWOOD CLIPS

25 YR. STANDARD ASPHALT SHINGLE

ALUMINUM EAVES/RAFTER

ALUMINUM FASCIA

2"X6" SUB-FASCIA

VENTED ALUMINUM SOFFIT

7/16" WAferBOARD WALL SHEATHING WRAPPED WITH TYRAX HAIR WRAP (WAferBOARD TO BE VENTED)

1"X3" STRAPPING @16"O.C.

8" ONE LAYER WOOD SING (OSB OR GRAY)

3-2"X8" PT BEAM

4"X16"X18" CONCRETE PER PAD

2-2"X4" TOP PLATE

2"X4" PRE-CUT SIDO WALL @16"O.C.

2"X4" BOTTOM PLATE

3/4" EDGEGLD SUB-FLOOR

2"X8" PT FLOOR JOIST @16"O.C.

3-3-1/2" STANGHD AROOF

GRADE

GRADE

GRADE

GRADE